

FIXING SYSTEM - MINI SERIES

ON DIN RAIL

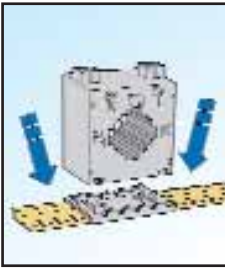

BASE MOUNTED WITH FEET

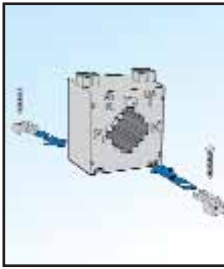

TO CABLE OR BUS BAR

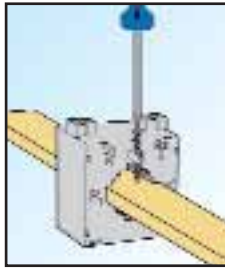

FIXING SYSTEM - SMALL SERIES

ON DIN RAIL

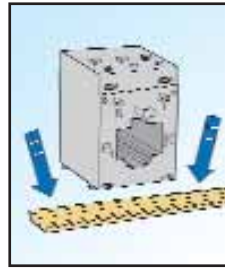

BASE MOUNTED WITH FEET

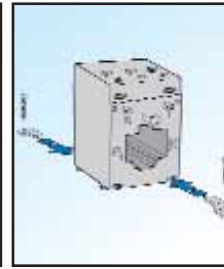

TO CABLE OR BUS BAR

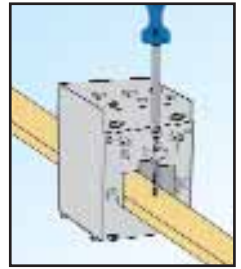

FIXING SYSTEM - STANDARD SERIES

ON DIN RAIL

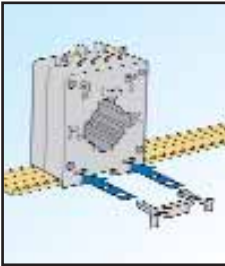

BASE MOUNTED WITH FEET

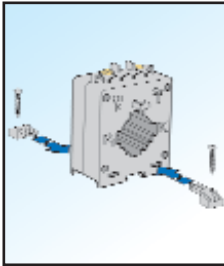

TO CABLE OR BUS BAR

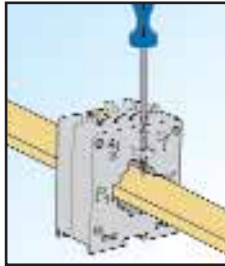

CONNECTION DIAGRAM - MINI SERIES

WITH FAST-ON (6,3 mm)

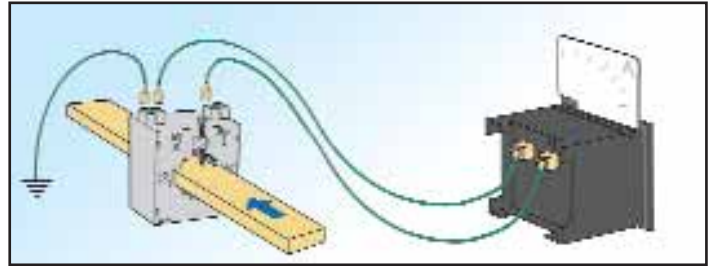

CONNECTION DIAGRAMS - SMALL SERIES

WITH METAL POINT CABLE TERMINAL

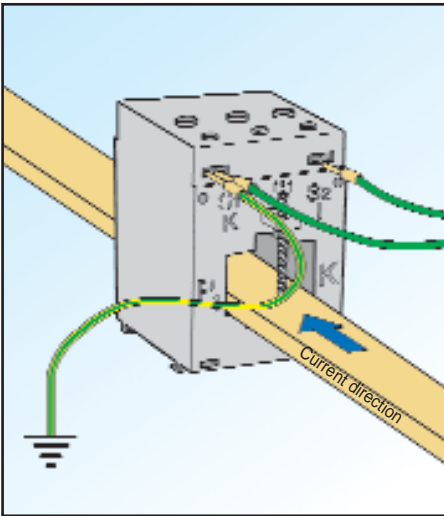

METAL FORK CABLE TERMINAL

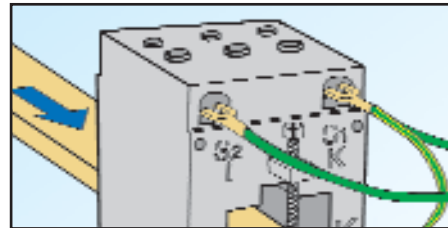

WITH FAST-ON (6,3 mm)

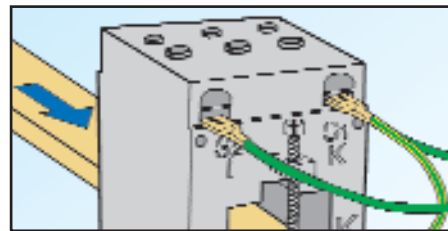

FIXING OF TERMINALS COVER AND LEAD SEAL

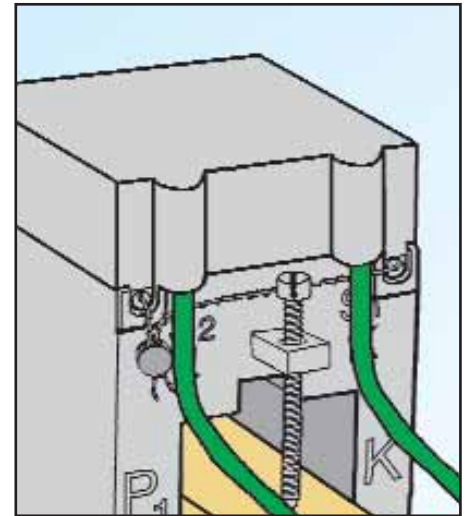

CONNECTION DIAGRAMS - STANDARD SERIES

WITH METAL FORK CABLE TERMINAL

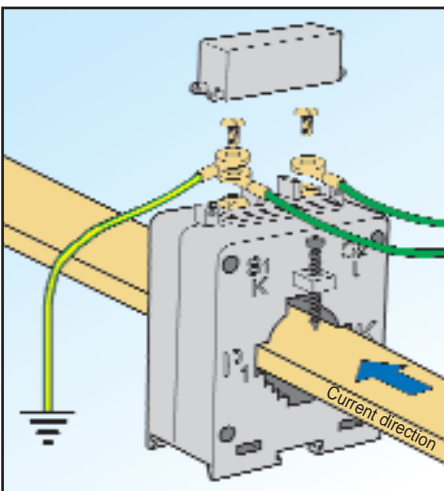

WITH FAST-ON (6,3 mm)

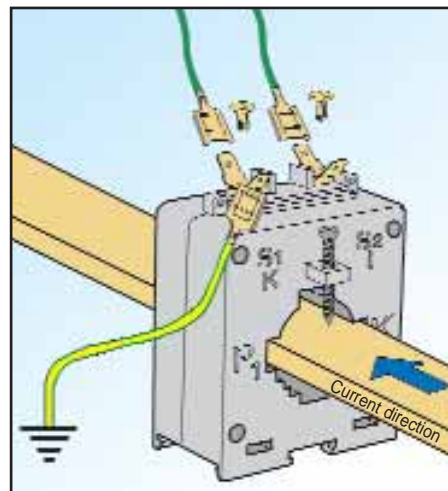

FIXING OF TERMINALS COVER AND LEAD SEAL

