

SYSTEME DE FIXATION - SÉRIE MINI

SUR RAIL DIN

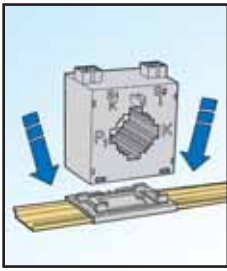

MONTAGE ADOSSÉ

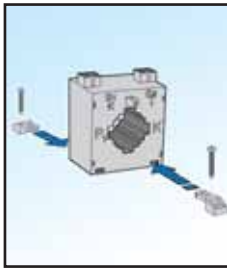

CABLAGE SUR BUS BARRE

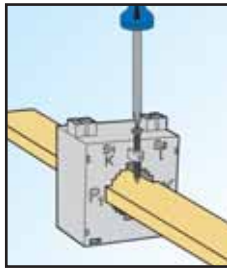

SYSTEME DE FIXATION - SÉRIE SMALL

SUR RAIL DIN

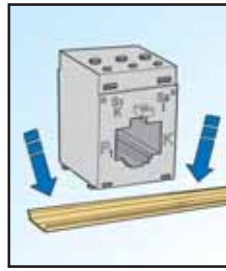

MONTAGE ADOSSÉ

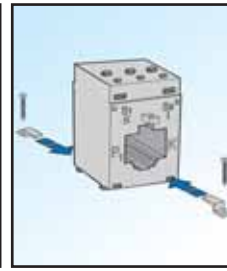

CABLAGE SUR BUS BARRE

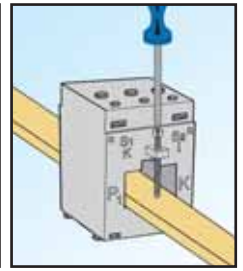

SYSTEME DE FIXATION - SÉRIE STANDARD

SUR RAIL DIN

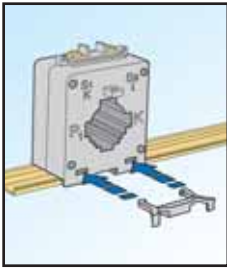

MONTAGE ADOSSÉ

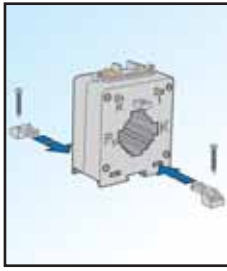

CABLAGE SUR BUS BARRE



DIAGRAMME DE CONNEXION - SÉRIE MINI

AVEC FASTON (6,3 mm)

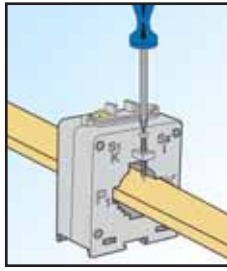
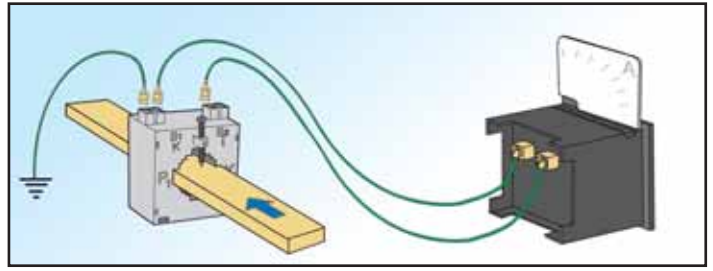

DIAGRAMMES DE CONNEXION - SÉRIE SMALL

AVEC EMBOUT MÉTALLIQUE

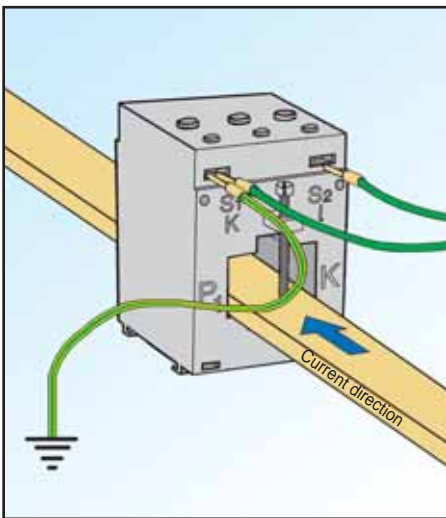

AVEC COSSE A FOURCHE

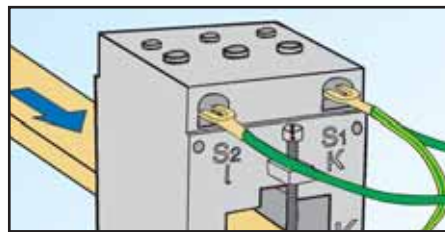

AVEC FASTON (6,3 mm)

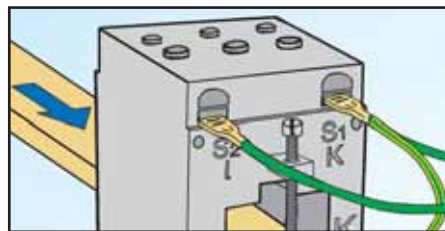

MONTAGE DU CAPOT DE PROTECTION ET SELLAGE

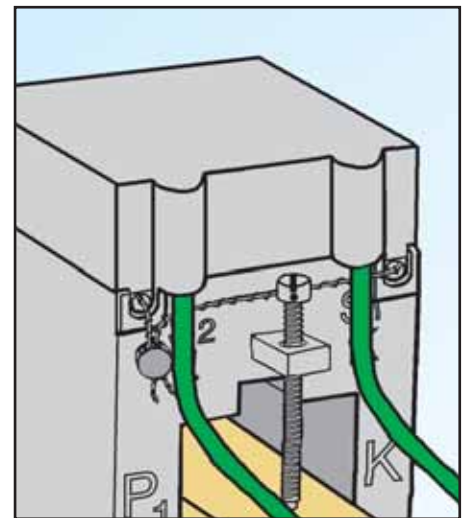

DIAGRAMMES DE CONNEXION - SÉRIE STANDARD

AVEC COSSE RONDE

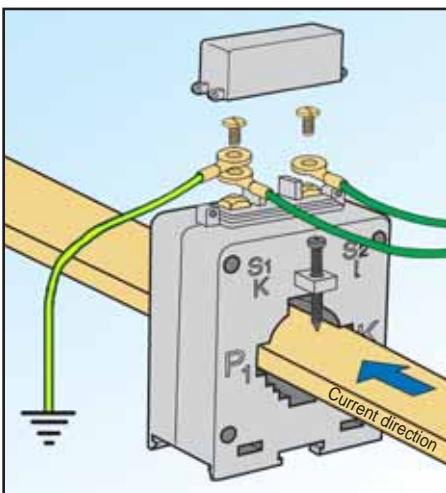

AVEC FASTON (6,3 mm)

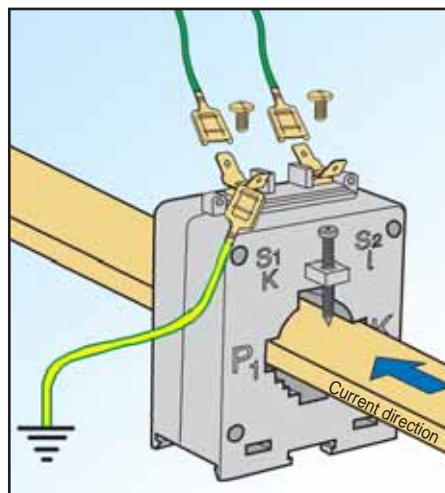

MONTAGE DU CAPOT DE PROTECTION ET PLOMBAGE

