

COMMUTATORI - INTERRUTTORI



CARATTERISTICHE TECNICHE

I **Commutatori**, **interruttori** ed **invertitori** presenti in questo catalogo sono stati costruiti seguendo le indicazioni delle seguenti norme: CEI 23-11, CEI 17-11, CEE 24, VDE 0660 T107.

- I contatti sono elettrosaldati in Argento/Nichel.
- Il materiale di isolamento è in policarbonato e le viti sono in acciaio zincato.
- La tensione di riferimento all'isolamento è di 660V con corrente nominale in AC1 di 12A.
- La vita meccanica è di 1,5 milioni di commutazioni con temperatura di esercizio compresa tra -20°C e +60°C.
- Il grado di protezione sui morsetti è in IP40 avendo superato il test del "dito elettrico".
- Tale protezione può comunque essere aumentata con l'utilizzo (a montaggio avvenuto) delle apposite protezioni.

In queste apparecchiature non è previsto il morsetto di terra, in quanto tutte le parti rotanti sono completamente isolate dalle parti in tensione.

DIMENSIONI in mm



- La dimensione 52,5 mm corrisponde a 3 moduli DIN (17,5 mm ognuno)
- Peso medio: 0,13 kg

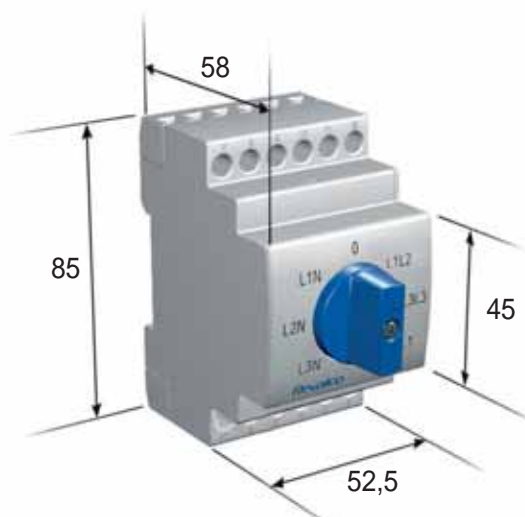

- La dimensione 52,5 mm corrisponde a 3 moduli DIN (17,5 mm ognuno)
- Peso medio: 0,22 kg

COMMUTATORI VOLTMETRICI

PER 3 TENSIONI DI FASE

PER 3 TENSIONI CONCATENATE

PER 3 TENSIONI CONCATENATE E 3 TENSIONI DI FASE

PER 3 TENSIONI CONCATENATE E 3 TENSIONI DI FASE IN CUSTODIA

1RCO1215D

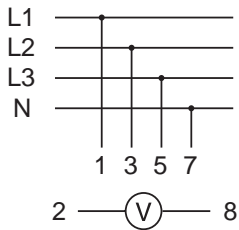
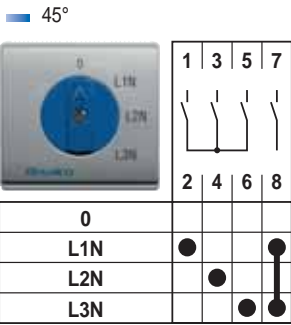

1RCO1216D

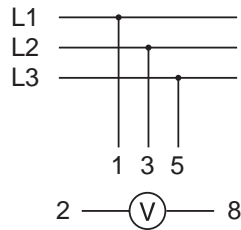
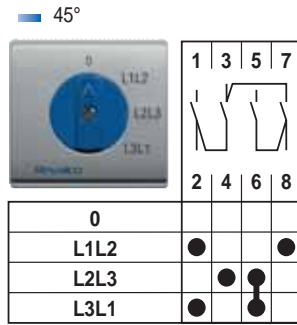

1RCO1218D

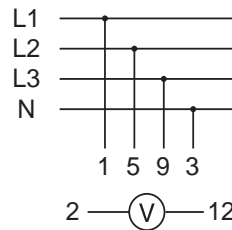
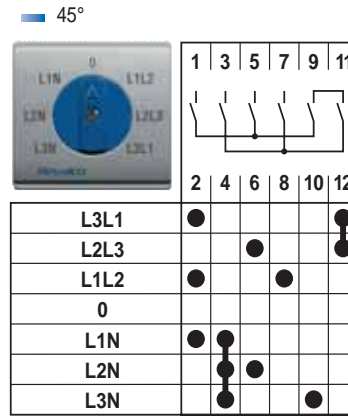

1RCO1218DS

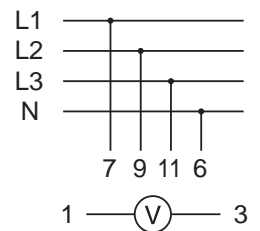

COMMUTATORI AMPEROMETRICI

UNIPOLARE PER 3 RIDUTTORI

UNIPOLARE PER 3 RIDUTTORI IN CUSTODIA

1RCO1222D

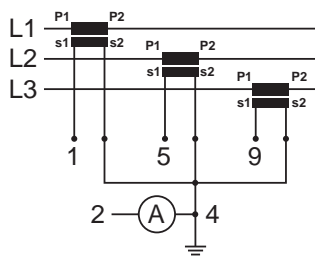
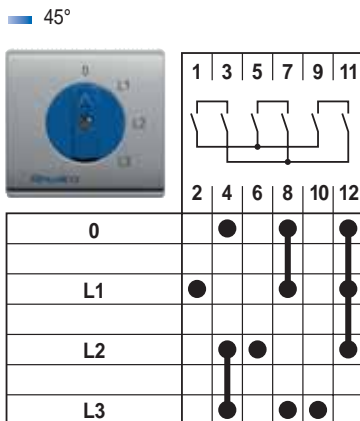

1RCO1222DS

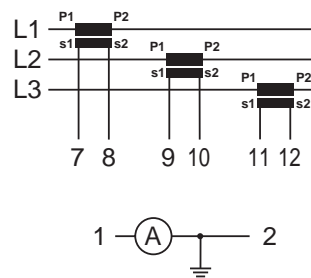

COMMUTATORI DI LINEA

INVERTITORI DI MARCIA

UNIPOLARE

1RCO1205D

45°

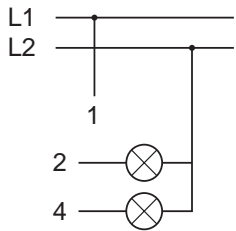
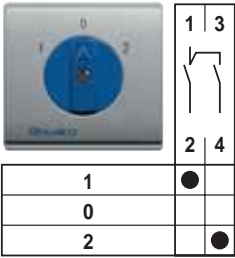

BIPOLARE

1RCO1206D

45°

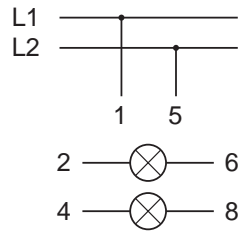
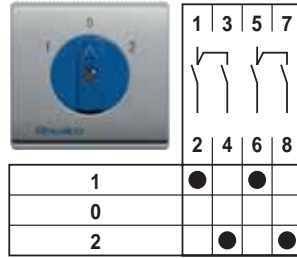

TRIPOLARE

1RCO1207D

45°

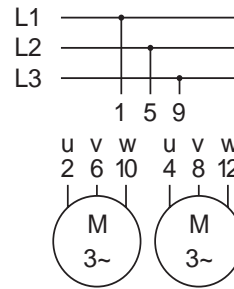
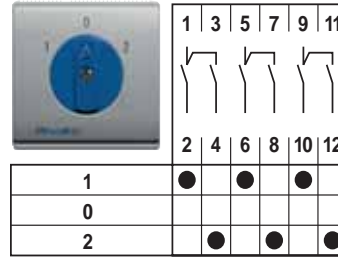

TRIPOLARE

1RINV1208D

45°

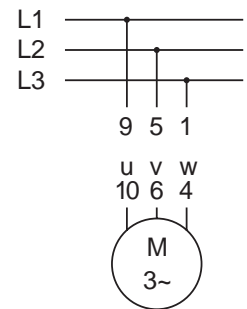
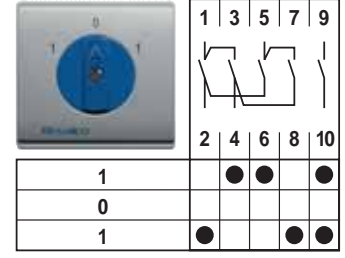

INTERRUTTORI

UNIPOLARE

1RIN1201D

45°

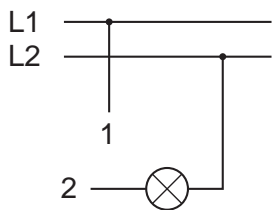
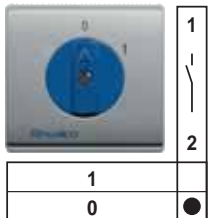

BIPOLARE

1RIN1202D

45°

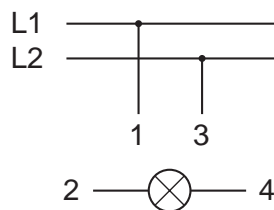
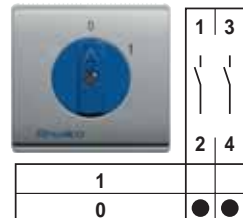

TRIPOLARE

1RIN1203D

45°

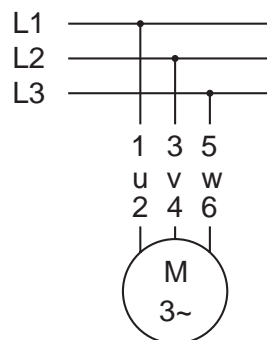
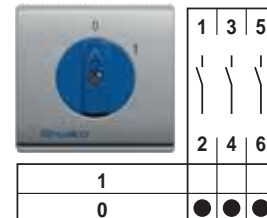

QUADRIPOLORE

1RIN1204D

45°

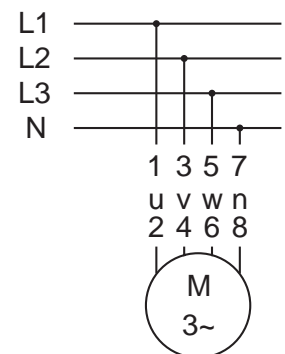
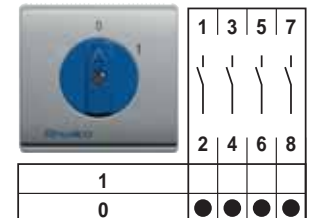

ACCESSORI

PROTEZIONI

AR109DF Cuffia di protezione flessibile, trasparente

